

# Pressure Transmitter with CANopen Interface

S M C

## Main features

- Measuring ranges 0...1 bar up to 0...2000 bar
- Integrated CANopen interface (CANopen 2.0 A - optional B)
- Media temperature range -40°C to 125° C
- Shock and vibration resistance > 1000 g shock, > 20 g vibration
- No internal transmitting media (fully welded, "dry" measuring cell)
- Degree of protection from IP67
- Compact and robust stainless steel design
- Highly reliable

## Applications

- General industrial uses
- Hydraulics
- Pneumatics
- Mechanical engineering
- Plant engineering and automation
- Automotive industry
- Environmental engineering
- Air conditioning
- Agricultural engineering

## Description

The powerful and reasonable CANopen pressure transducer has excellent properties due to its stainless steel diaphragm and semiconductor thin-film technology, suggesting its use in most areas of industrial applications. Its robust design guarantees high reliability also in rugged conditions.

The CAN controller meets the requirements of a CAN protocol acc. to Standard 2.0 A (optional B) and permits data rates of up to 1 MBit/s.



### Specifications

#### PRESSURE RANGE

Measuring range*	p [bar]	1,0	1,6	2,0	2,5	4,0	6,0	10,0	16,0
Overload pressure	p [bar]	6	6	6	6	10	20	20	40
Burst pressure	p [bar]	9	9	9	9	15	30	30	60
Measuring range*	p [bar]	20	25	40	60	100	160	200	250
Overload pressure	p [bar]	40	100	100	200	200	400	400	750
Burst pressure	p [bar]	60	150	150	300	300	600	600	1000
Measuring range*	p [bar]	400	600	1000	1600	2000			
Overload pressure	p [bar]	750	840	1200	2400	2400	(vacuum, relative pressure, + -		
Burst pressure	p [bar]	1000	1050	1500	3000	3000	or absolute pressure are available)		

#### ELECTRICAL PARAMETER

Supply voltage	U [V <sub>DC</sub> ]	10...32		
Supply current	I [mA]	< 30		
CAN interface		acc. to DIN ISO 11898	CAN2.0A	CAN 2.0B optional
CAN protocol		CANopen		
Response time* (10...90%)	t [ms]	< 1		
Withstand voltage	U [V <sub>DC</sub> ]	350		

#### ACCURACY

Accuracy @ RT	% of the range ≤ 0,50**	option ≤ 0,25	** incl. nonlinearity, hysteresis, repeatability, zero-offset- and final-offset (acc. to IEC 61298-2)	
	BFSL	≤ 0,125		
Non-linearity	% of the range	≤ 0,15		
Repeatability	% of the range	≤ 0,10		
Stability/year	% of the range	≤ 0,10		

#### ACCEPTABLE TEMPERATURE RANGES

Measuring medium	T [°C]	-40...125
Ambience	T [°C]	-40...105
Storage	T [°C]	-40...125
Compensated range*	T [°C]	-20...85
Temperature coefficient within the compensated range		
Mean TC offset	% of the range	≤ 0,15 / 10K
Mean TC range	% of the range	≤ 0,15 / 10K
Total error	% of the range	-40°C 2,00%
	% of the range	105°C 2,00%

#### MECHANICAL PARAMETER

Parts in contact with the measuring medium*		stainless steel	silicon
Housing*		stainless steel	brass, aluminium
Shock resistance	g	1000	acc. to IEC 68-2-32
Vibration resistance	g	20	acc. to IEC 68-2-6 und IEC 68-2-36
Mass	m [g]	80-120	depending on design
CE - conformity		EC directive 89/336/EWG	
IP system of protection		The IP system of protection as specified in the data sheets generally applies, with their mating plug connected. Relative pressure transmitters usually require a ventilated mating plug and/or cable to allow for pressure compensation. From a pressure range of 60bar, a ventilated mating plug and/or cable is not necessarily required.	

\* others upon request

Configurations -examples-

SMC with M12-conn.



M5x0,5  
(S 707)



integrated  
y-piece



M12x1  
(S 763)

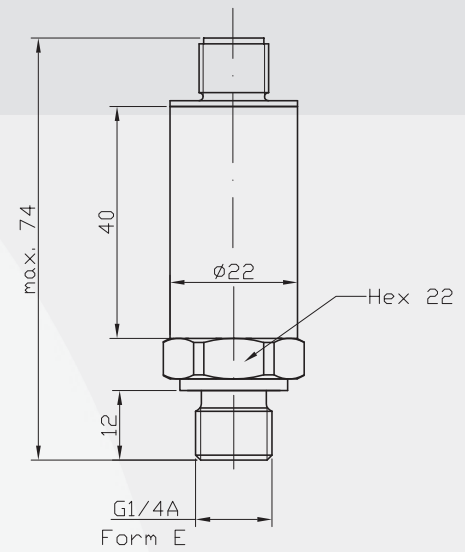

(deviations for absolute pressure are possible)

Connectors\*

male socket  
M12x1 (S 763)

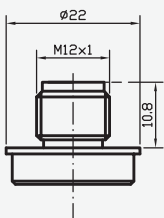

Pressure Connections\*

G 1/4 A; DIN 3852; Form E

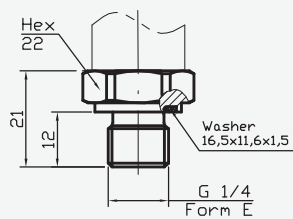

G 1/4 B

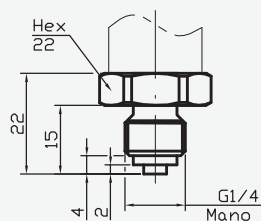

G 1/2 B

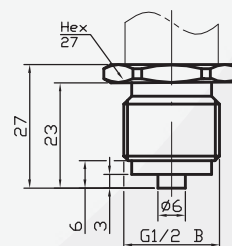

1/4 NPT

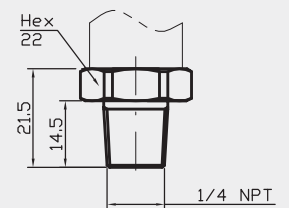

\* Custom-made adjustments acc. to pressure connections and connecting options are possible.

# SMC



Pressure Transmitter  
with CANopen Interface

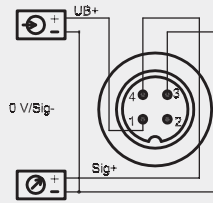
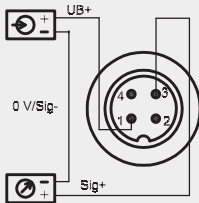

## Electrical Connections\* (left: 2-wire, right: 3-wire)

male  
socket  
M12x1  
(S 763)



### Legend

 power supply  
 consumer

 red  
 black  
 white

\* Custom-made adjustments acc. to pressure connections and connecting options are possible.

### Product line

DS4	Electronic Pressure Switch	SMC	Pressure Transmitter with CANopen Interface
DPSX9I	Intrinsically Safe Electronic Pressure Switch for Current	SME	Pressure Transmitter in Miniature Design
DPSX9U	Intrinsically Safe Electronic Pressure Switch for Voltage	SMF	Pressure Transmitter with Flush Diaphragm
PS1	Level Sensor	SMH	High Pressure Transmitter
PSX2	Intrinsically Safe Level Sensor	SML	Pressure Transmitter for Industrial Application
SHP	High Precision Pressure Transmitter	SMO	Pressure Transmitter in Mobile Hydraulics
SIS	Low Pressure Transmitter in Short and Compact Design	SMS	OEM Pressure Transmitter for Hydraulics and Pneumatics
SIL	Low Pressure Transmitter for Industrial Application	SMX	Intrinsically Safe Pressure Transmitter for Industrial Application
SKE	High Temperature Pressure Transmitter with Detached Electronics	TPS	Multi-Function Transmitter for Pressure and Temperature
SKL	High Temperature Pressure Transmitter with Cooling Fins		



**MEGATRON, s.r.o.**

Mrštíkova 16 • 100 00 Praha 10  
Tel.: 274 780 972 • Fax: 274 780 975

E-mail: [info@megatron.cz](mailto:info@megatron.cz)  
[www.megatron.cz](http://www.megatron.cz)