

AWP 812

“Analog or CANopen Output, High Accuracy, IP67 Protection”



- Different stroke (measuring) lengths up to 5000mm
- Magnetic absolute measurement technology
- Robust stainless steel measuring wire
- Aluminium housing
- Analog or CANopen output
- Programmable analog output option
- IP67 protection class
- Compact design and easy mounting
- 1 m/s maximum movement speed
- Shock/vibration resistant

MEKANİK VERİLER

Measuring Range (stroke)	Different measuring lengths up to 5000mm
Max. Movement speed	1 m/s
Extension Force	12N
Protection Class	IP67
Operating Temperature	-40°C...+85°C
Material	Body: Aluminium
	Measuring wire: Stainless steel

MECHANICAL DIMENSIONS (mm)

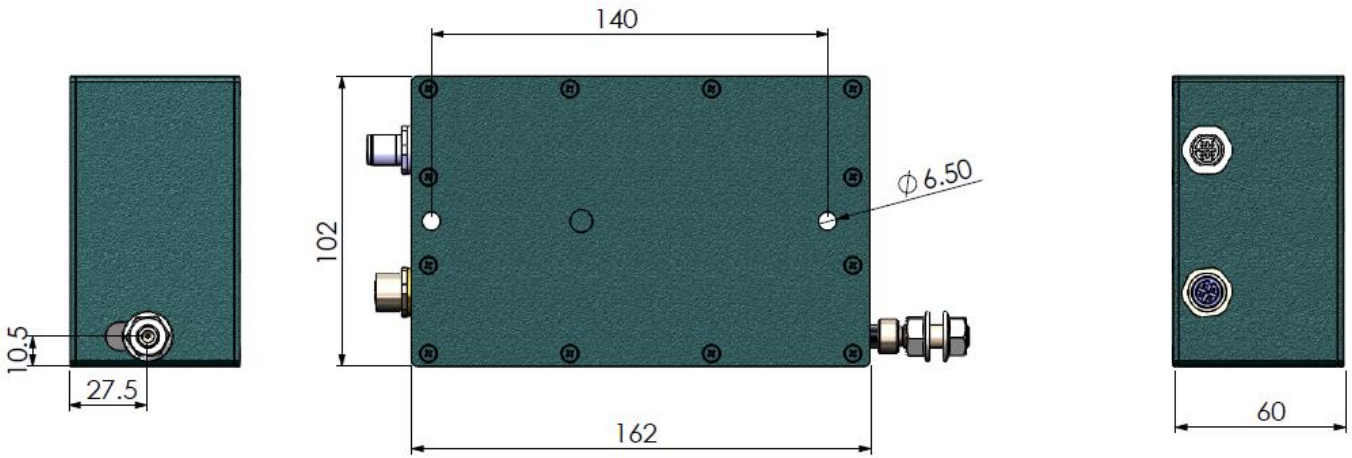

ANALOG VERSION

Electrical Specifications

Measuring range	Different measuring lengths up to 5000mm
Supply voltage	15...26VDC
Current consumption	≤60mA
Reverse polarity protection	Yes
Short circuit protection	Yes (only supply)
Response frequency	500 Hz
Resolution	0.05 mm
Linearity	±%0.5 FS
Output signal	Voltage: 0–10V, 0.5–4.5V, 0–5V Current: 4–20mA
Signal characteristics	Increasing (exmp: 4–20mA) Decreasing (exmp: 20–4 mA)
Sensing device	Magnetic absolute encoder
Electrical connection	M12 connector or cable

Electrical Connection

Signal	Cable	M12 / 5 pin male connector
V+(15...26 VDC)	Red	Pin 1
Analog output signal	Yellow	Pin 2
GND	Black	Pin 3
N/C	Green	Pin 4
N/C	Pink	Pin 5

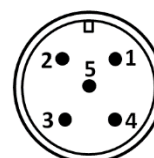

Order Code

Electrical Connection

S13M: M12/5 pin male connector
2M: 2m cable
 *Optional others

Model

AWP 812	-	XXXX	-	XXXX	-	XX
---------	---	------	---	------	---	----

Measuring Range

Different measuring lengths up to 5000 mm

Analog Output Signal

V : 0–10VDC
 V1 : 0–5VDC
 A : 4–20mA
 V3 : 0.5–4.5VDC
 NV : 10–0VDC
 NV1 : 5–0VDC
 NA : 20–4mA
 NV3 : 4.5–0.5VDC

ANALOG VERSION, PROGRAMMABLE

Electrical Specifications

Measuring range	Different measuring lengths up to 5000 mm
Supply voltage	15...26 VDC
Current consumption	≤60 mA
Reverse polarity protection	Yes
Short circuit protection	Yes (only supply)
Response frequency	500 Hz
Resolution	0.05 mm
Linearity	±%0.5 FS
Output signal	Voltage: 0–10V, 0.5–4.5V, 0–5V (programmable) Current: 4–20 mA (programmable)
Signal characteristics	Increasing (exmp: 4–20 mA) Decreasing (exmp: 20–4 mA)
Sensing device	Magnetic absolute encoder
Electrical connection	M12 connector or cable

Electrical Connection

Signal	Cable	M12 / 5 pin male connector
V+(15...26 VDC)	Red	Pin 1
Analog output signal	Yellow	Pin 2
GND	Black	Pin 3
N/C	Green	Pin 4
SPAN/ZERO	Pink	Pin 5

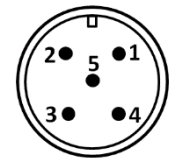

SETTING MEASUREMENT LIMITS: With this feature, you can set the minimum and maximum measurement limits.

In order to determine the **minimum measurement limit (lim1)**, the SPAN/ZERO and GND terminal are short-circuited for at least 3 seconds.

In order to determine the **maximum measurement limit (lim2)**, the SPAN/ZERO and GND terminal are short-circuited for at least 6 seconds.

To **return to the factory settings**, the SPAN/ZERO and GND terminal are short-circuited for at least 10 seconds.

SAMPLE SIGNAL OUTPUT GRAPHICS

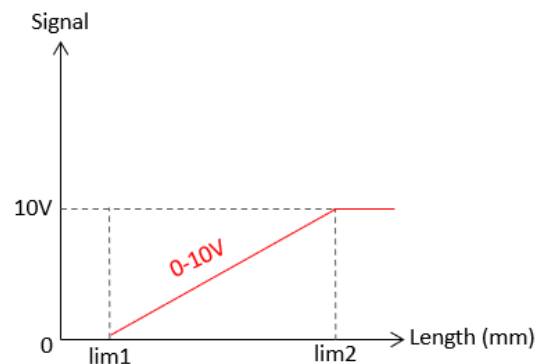
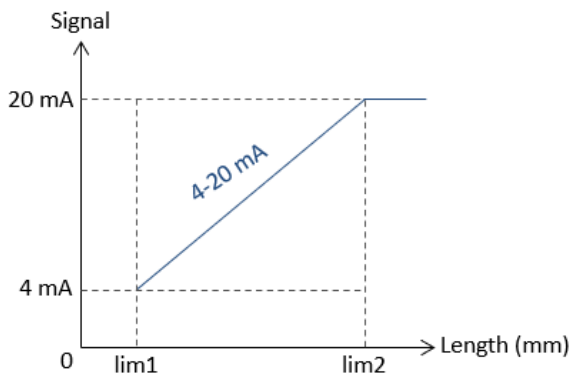

Order Code

Model	Electrical Connection	Programming Feature
AWP 812 - XXXX - XXXX - XX - XX	S13M: M12/5 pin male connector 2M: 2m cable *Optional others	PL: Programmable

Measuring Range

Different measuring lengths up to 5000 mm

Analog Output Signal

V : 0–10VDC
V1 : 0–5VDC
A : 4–20mA
V3 : 0.5–4.5VDC
NV : 10–0VDC
NV1 : 5–0VDC
NA : 20–4mA
NV3 : 4.5–0.5VDC

Electrical Specifications

Measuring range	Different measuring lengths up to 5000 mm
Supply voltage	12...30 VDC
Current consumption	≤60 mA
Reverse polarity protection	Yes
Short circuit protection	Yes (only supply)
Response frequency	500 Hz
Resolution	50 μm
Linearity	±%0.5 FS
Sensing device	Magnetic absolute encoder
Electrical connection	M12 connector or cable

CANopen Specifications

Communication Profile	CIA 301
Device Type	CANopen, CIA DS406
Node ID	Adjustable from 1 to 127 with LSS or SDO
Baud Rate	10 kBit/s, 20 kBit/s, 50 kBit/s, 100 kBit/s, 125 kBit/s, 250 kBit/s, 500 kBit/s, 800 kBit/s, 1 Mbit/s
PDO Data Rate	100 ms
Error Control	Heartbeat, Emergency Message
PDO	3 Tx PDO
PDO Modes	Event/Time triggered, Synch/Asynch
SDO	1 server
Position Information	Object Dictionary 0x6020
Termination Resistance	Optional 120 Ω

Electrical Connection

Signal	Cable	M12 / 5 pin male connector
CANSHIELD	CANSHIELD	Pin 1
V+(12...30VDC)	Red	Pin 2
GND	Black	Pin 3
CAN_H	Yellow	Pin 4
CAN_L	Green	Pin 5

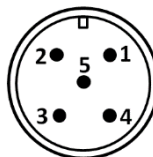

Order Code

Electrical Connection

S13M: M12/5 pin male connector
2M: 2m cable
 *Optional others

Model

AWP 812	-	XXXX	-	XXXX	-	X
---------	---	------	---	------	---	---

Measuring Range

Different measuring lengths up to 5000 mm

Output Signal

C: CANopen

MOUNTING AND WARNINGS

1. Never release the wire after pulling. Otherwise, the coil spring will be damaged.

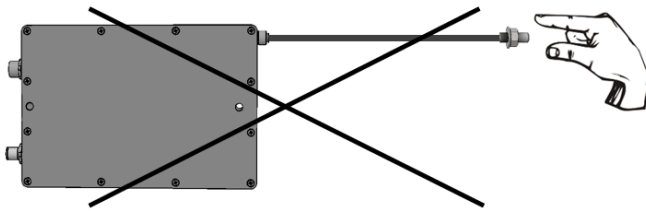

2. Mount the sensor according to the mounting directions shown below.

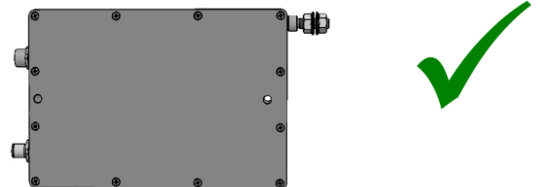
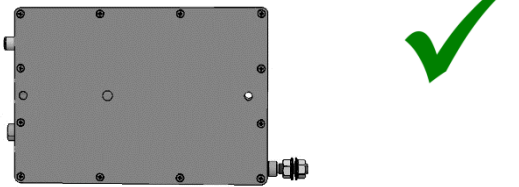
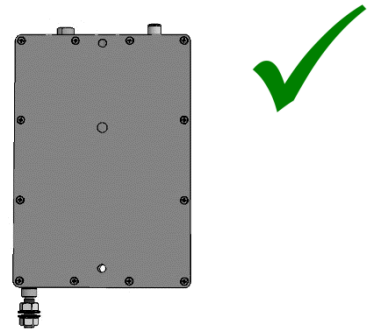
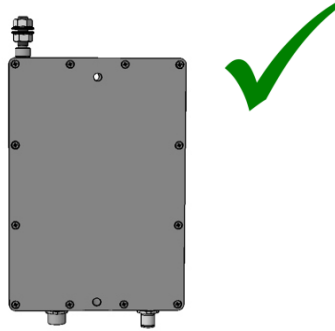
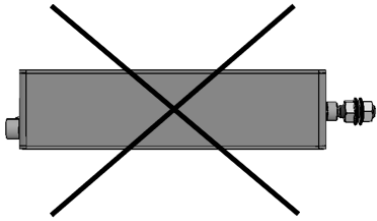

3. If there is a trickle of water (like a rain), the wire outlet must not be a drip of water upstream. If needed please use guide rollers.

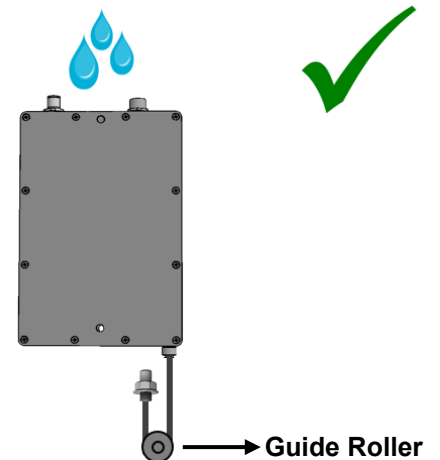
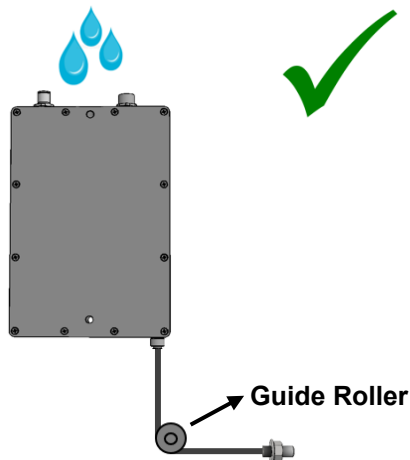
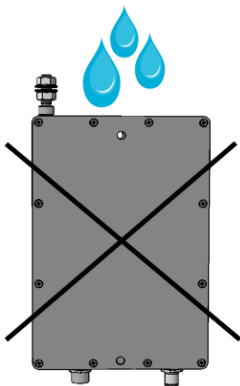

4. The wire should not be pulled in angular. If needed, please use guide rollers.

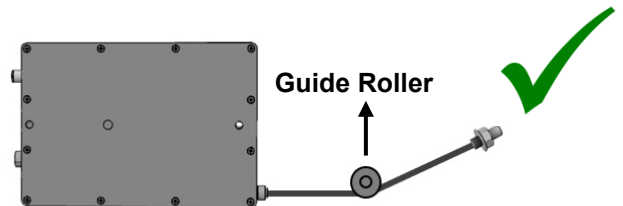
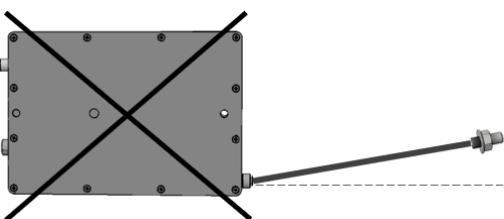

Important Note(!): Failure to comply with these recommendations, the malfunctions that may occur will not be under the warranty.